

NIVOVAS Kft.

# NIVO-KIT

Szerelési útmutató

# SZERELŐDOBOZ TARTALMA

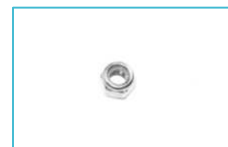

1.



1.11



1.12



1.13



1.14



1.15



1.16



1.17





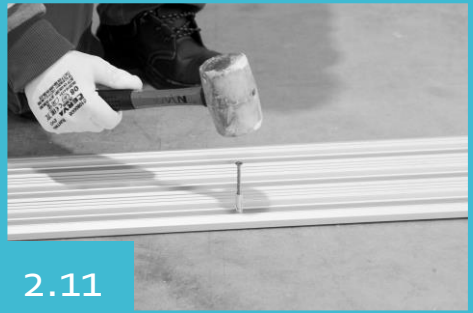
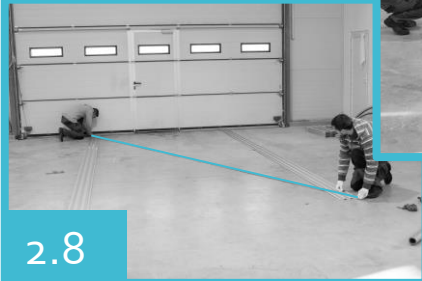
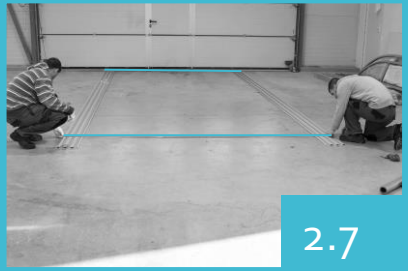
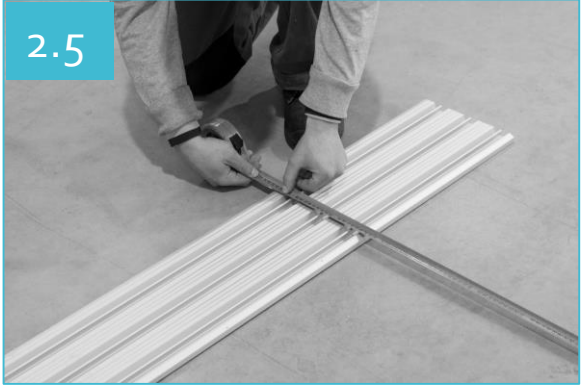
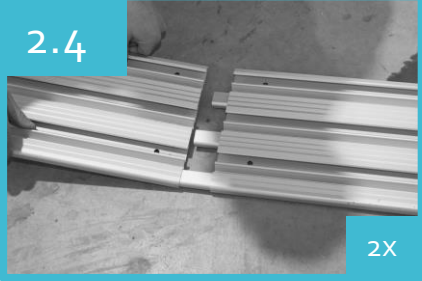
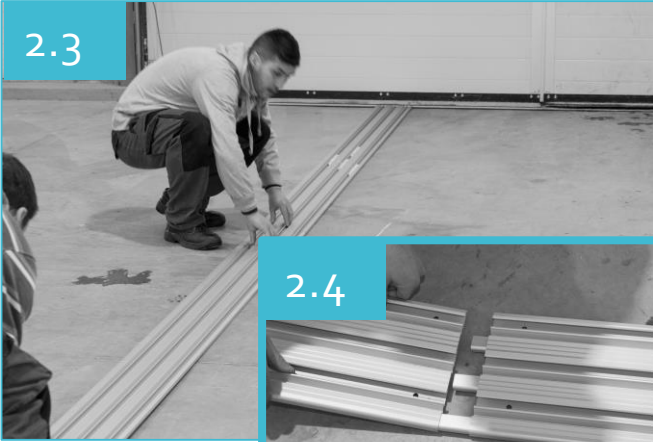
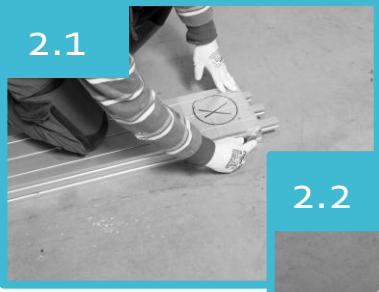



3.

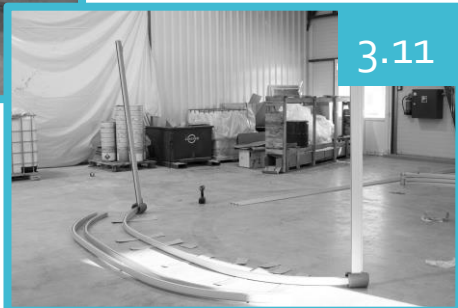
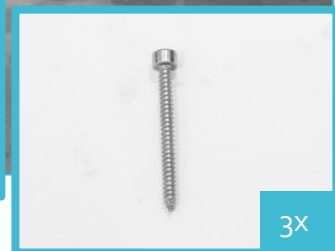



3.14



3.15



3.16



3.17



3.18



3.19



3.20



3.21



3.22



3.23

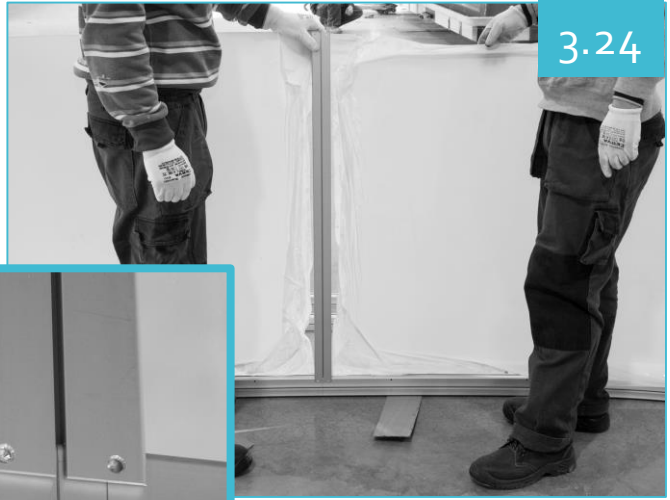

3.24





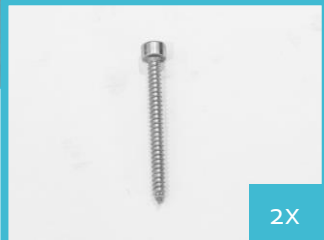
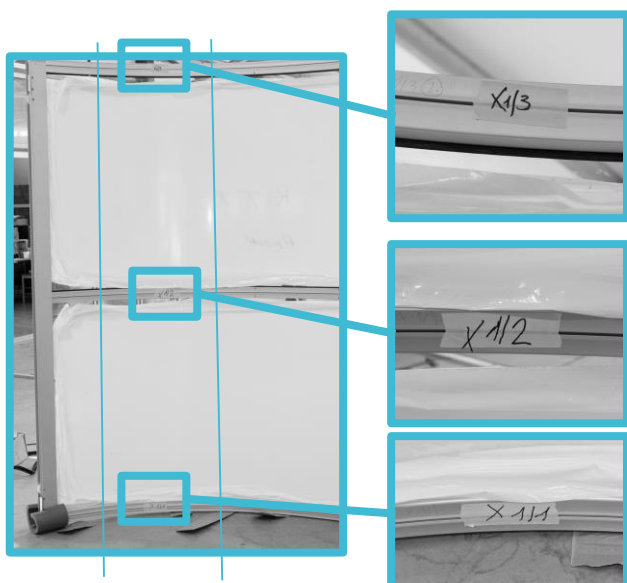

2X

2X

3.29



3.30



3.31

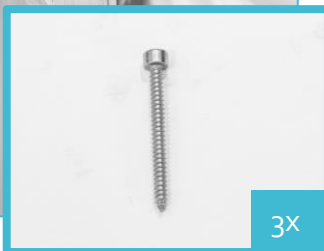

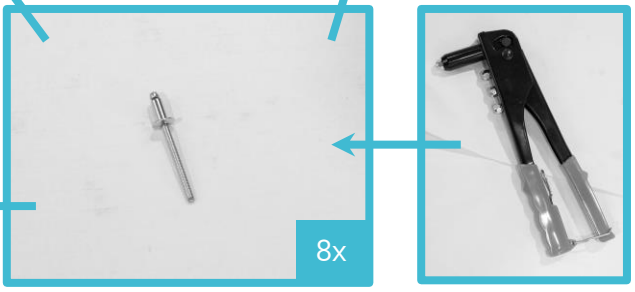
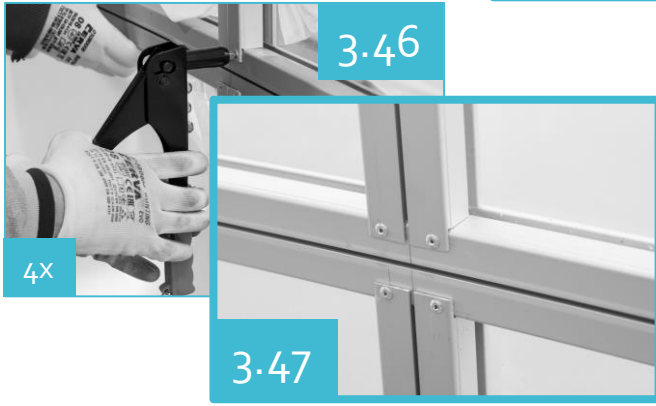
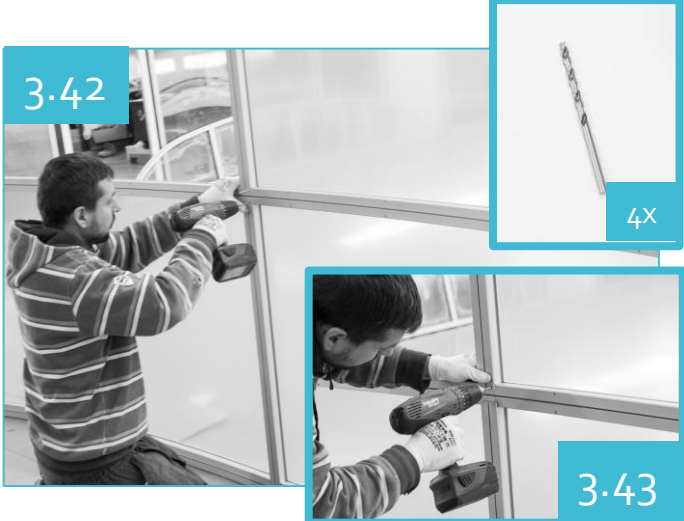





3.52



3.55



3.53



3.54



3.56

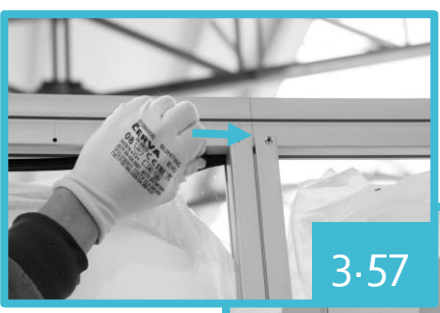

3.57



3.59

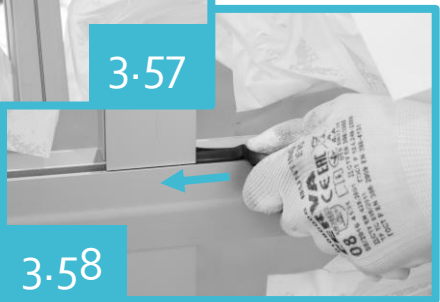

3.58



3.60



3.61

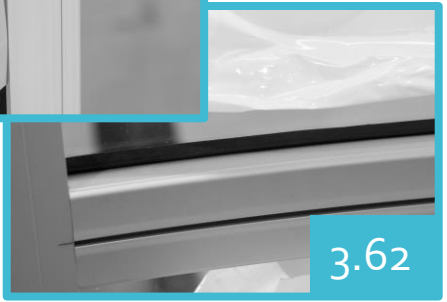

3.62



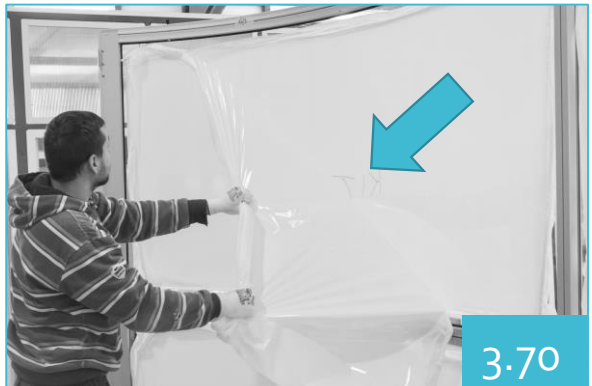
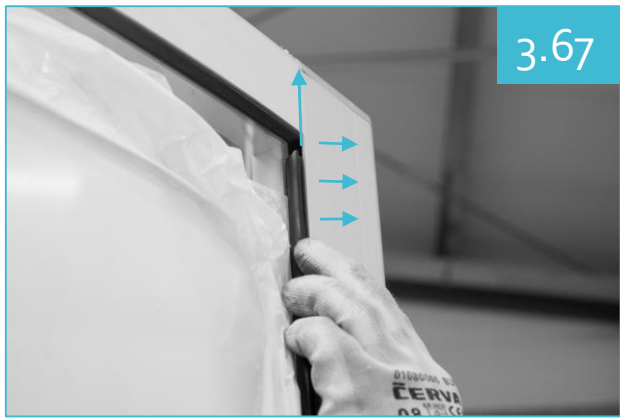



3.71



3.74



3.72



3.73



1X



3.75



3.76



1X



3.77



3.78



3.79



3.80



3.81

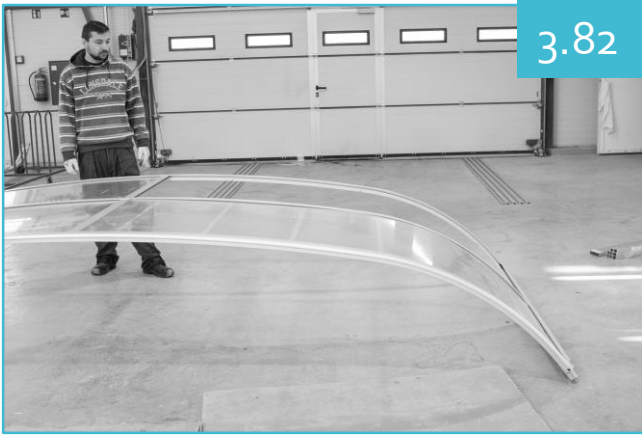

3.82

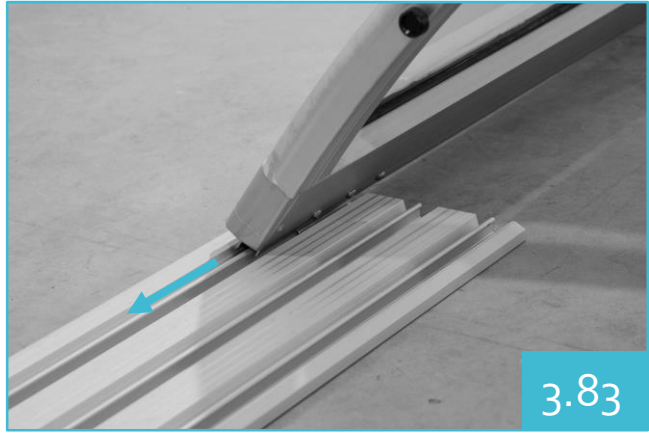

3.83



3.84

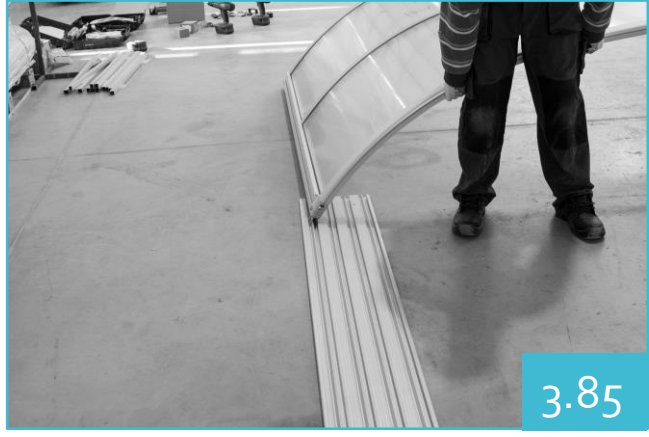

3.85



3.86



3.87





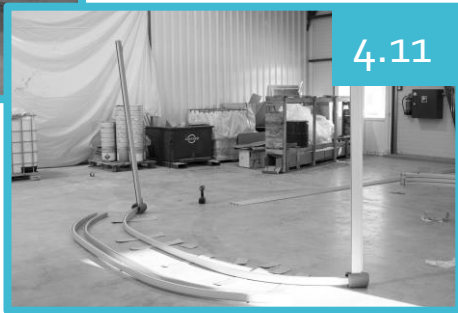
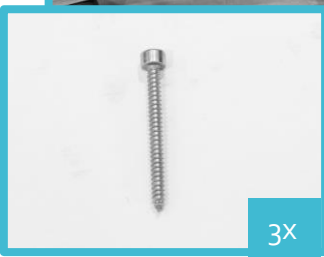
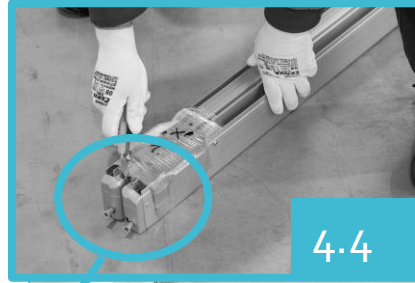



4.14



4.15



4.16

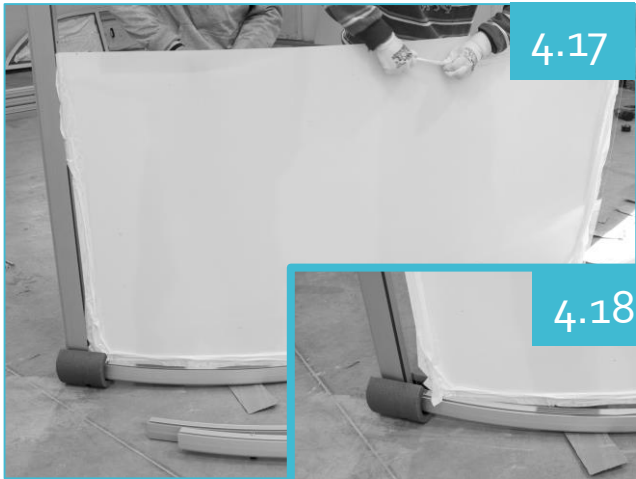

4.17



4.18



4.18



4.19



4.20



4.23



4.21



4.22



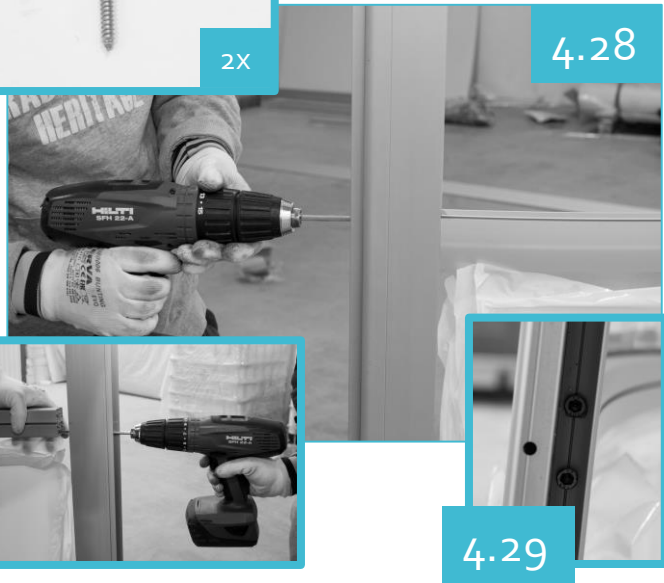
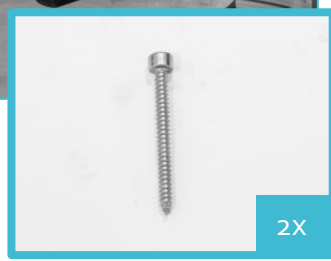
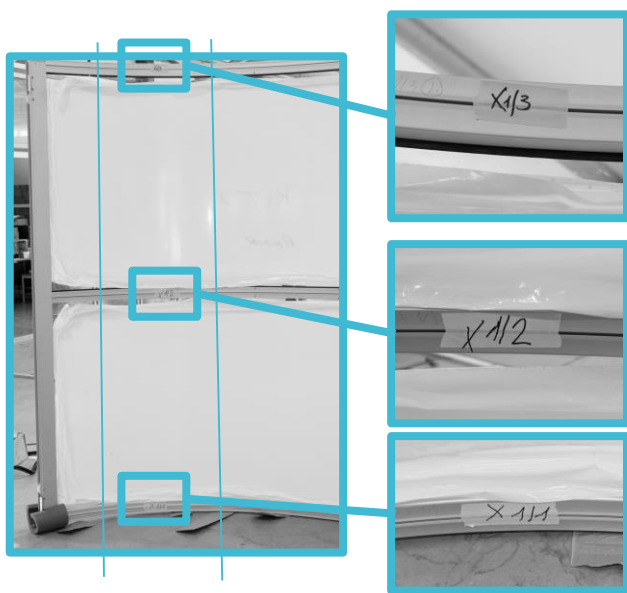





4.31



4.32



4.33



4.34



3x



4.35

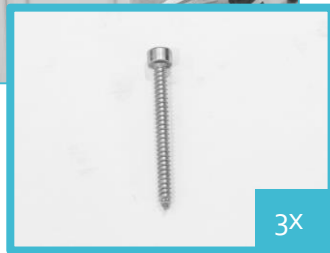

3x



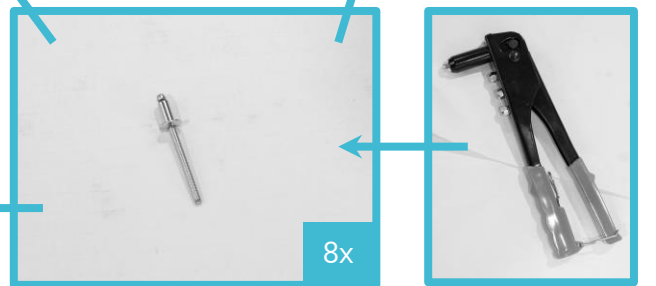



4.47



4.50



4.48



4.49



4.51



4.52



4.53



4.54



4.55



4.56



4.57

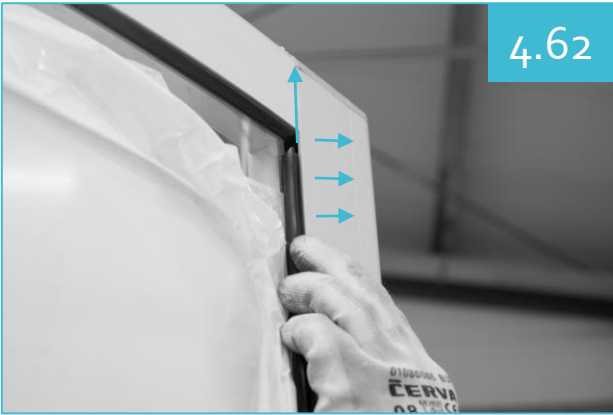



4.66



1X



4.69



4.68

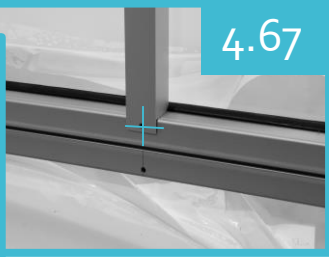

4.67



4.70



4.71



1X



4.72



4.73



4.74



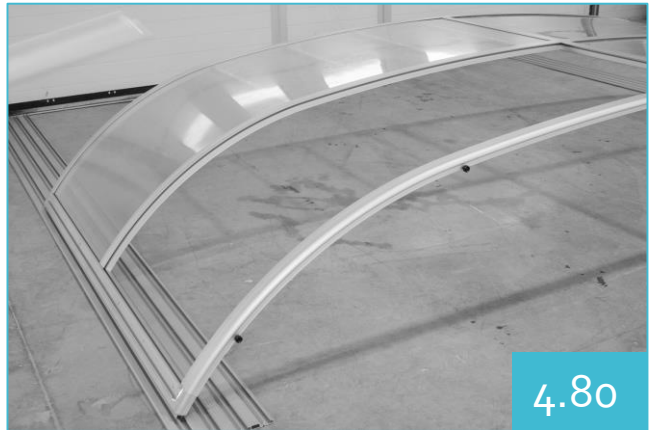
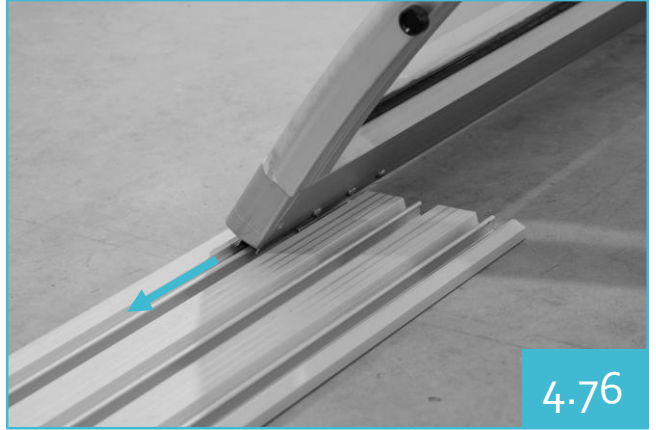
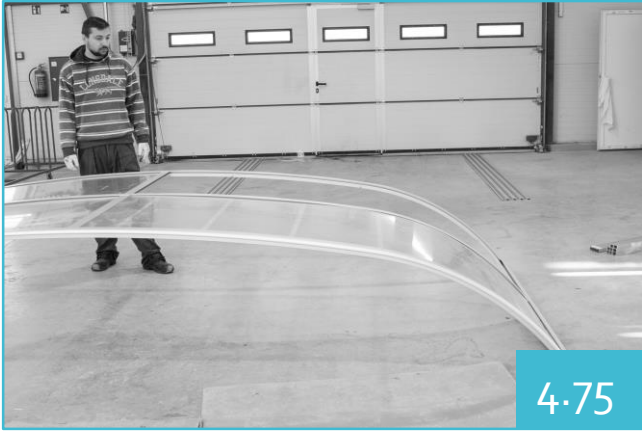



4.81

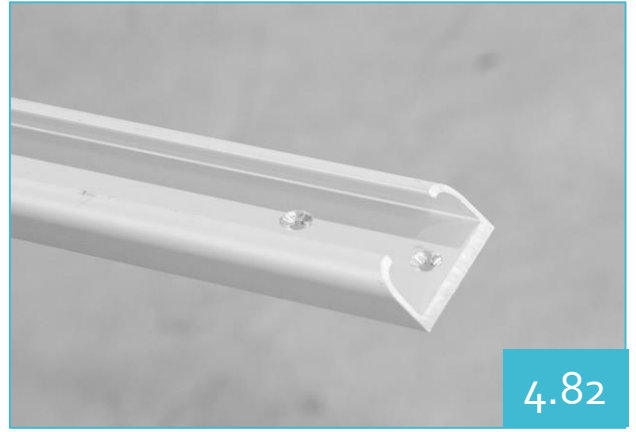

4.82



4.83



4.84

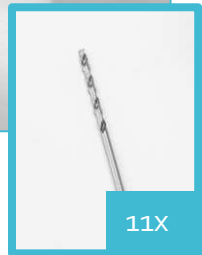

11X

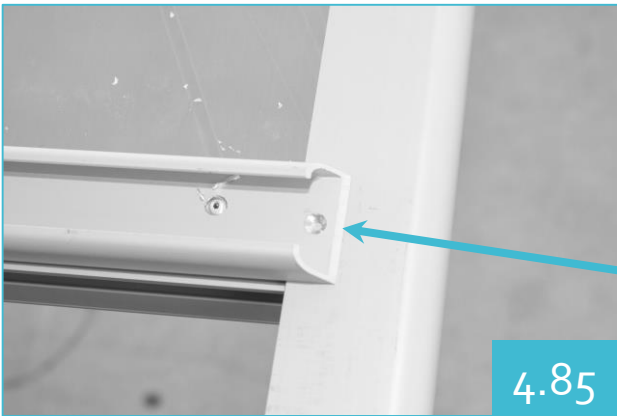

4.85



8x



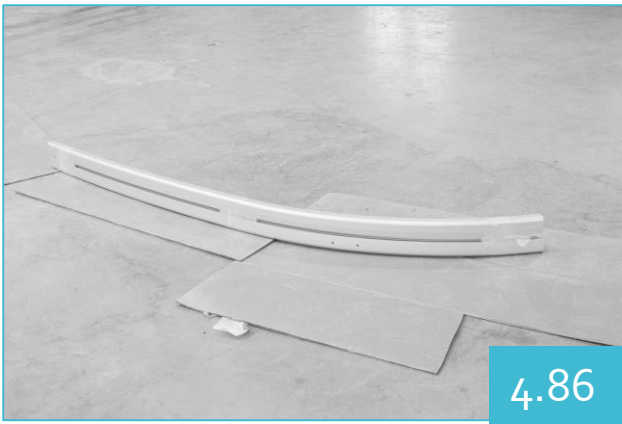

4.86



4.87



4.88



4.89



4.90

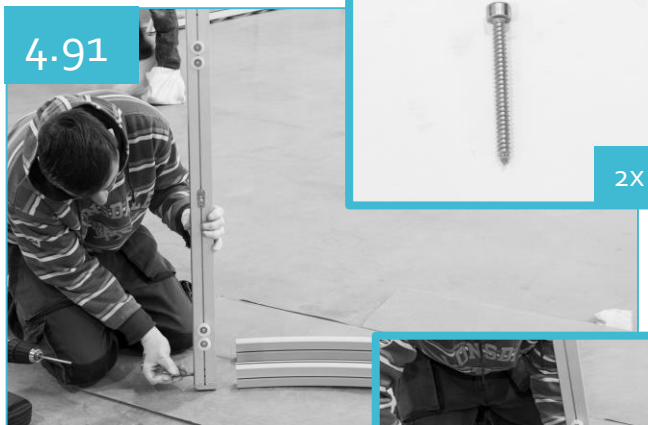

4.91



2X





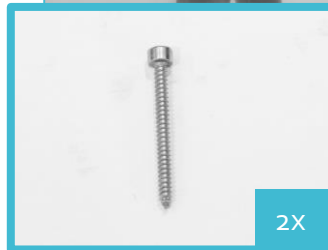
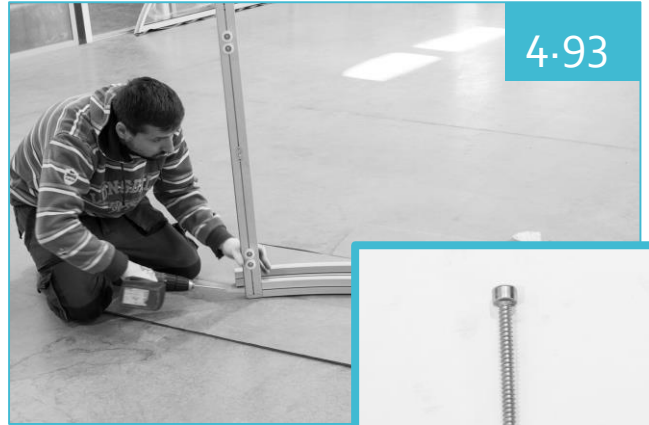
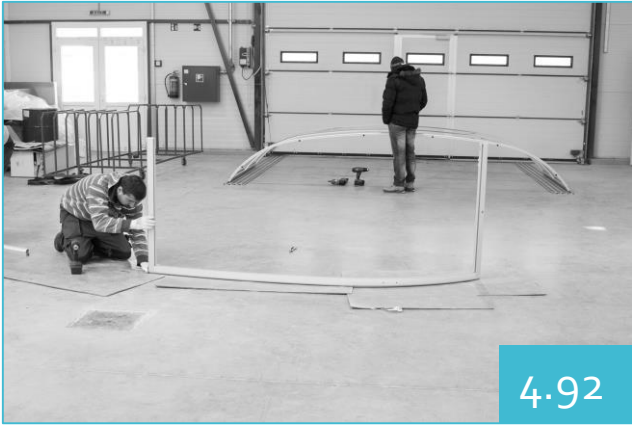



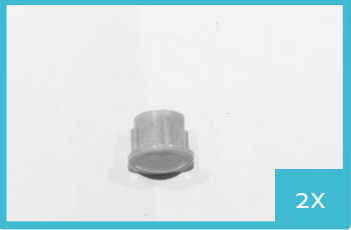

4.99

2X



4.100

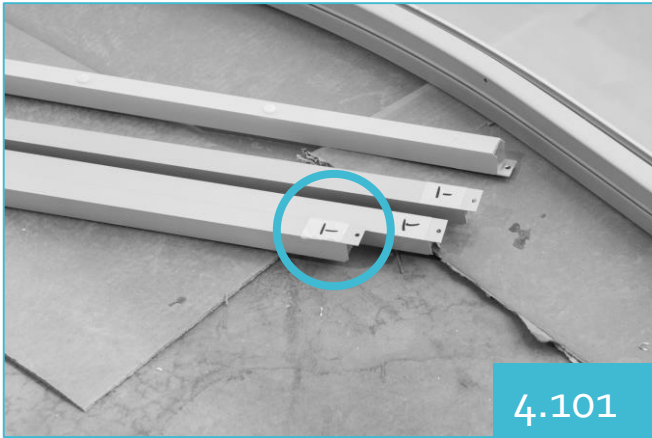

4.101



4.102

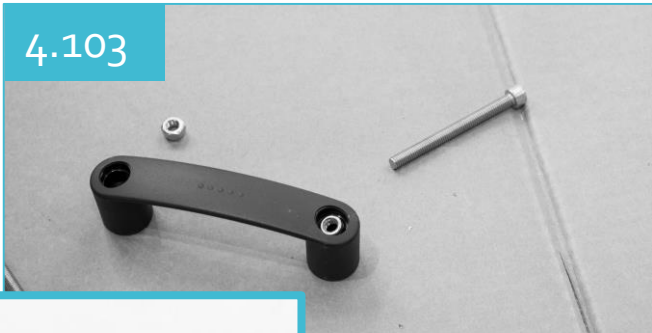
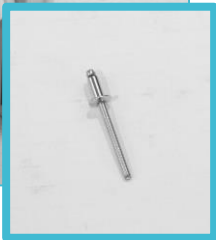

4.103



2X



4.104

2X

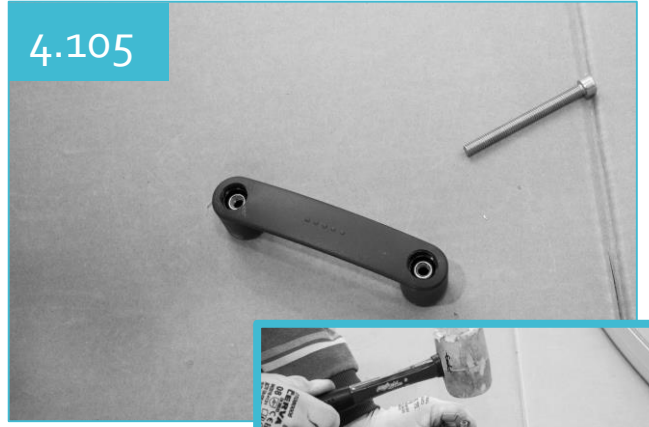

4.105



4.106

2X

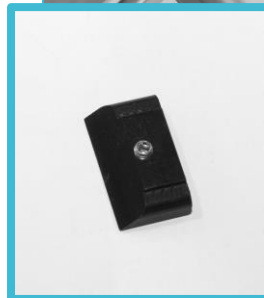
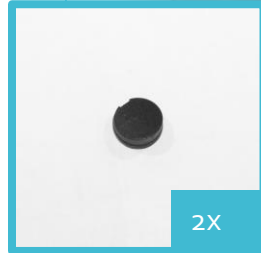



4.114



4.115



4.116



4.117



4.118



4.119



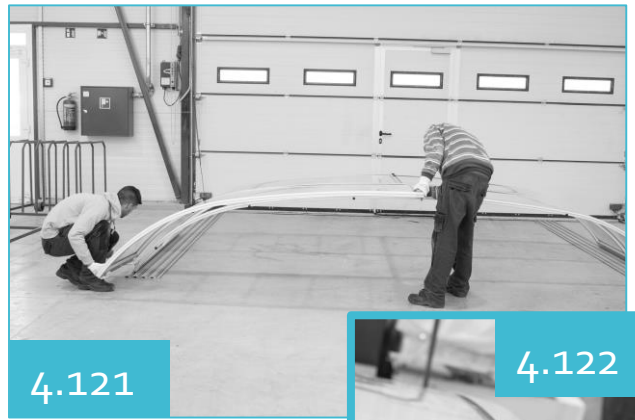



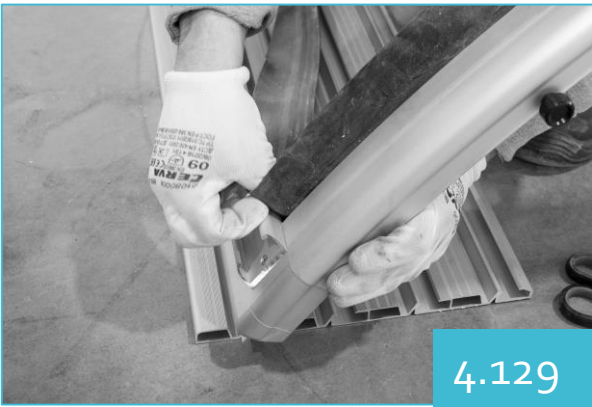

4.129



4.130



4.131



4.132

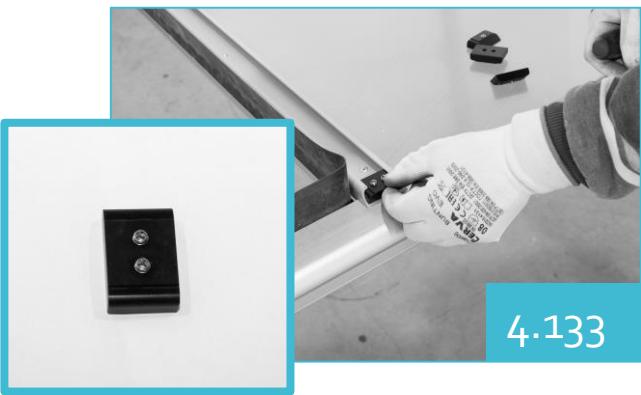

4.133



4.134

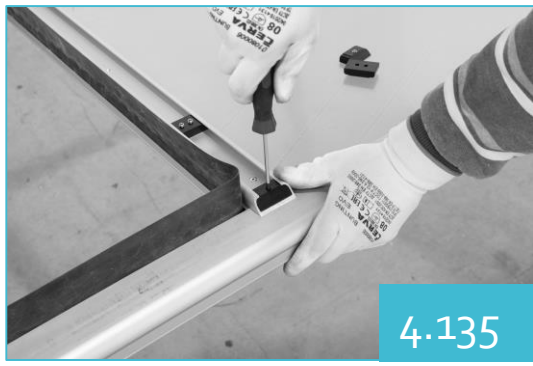

4.135



4.136



4.137



4.138



4.139

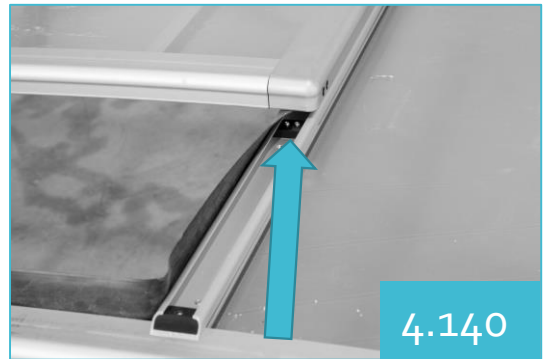

4.140



4.141



4.142



4.143



4.144

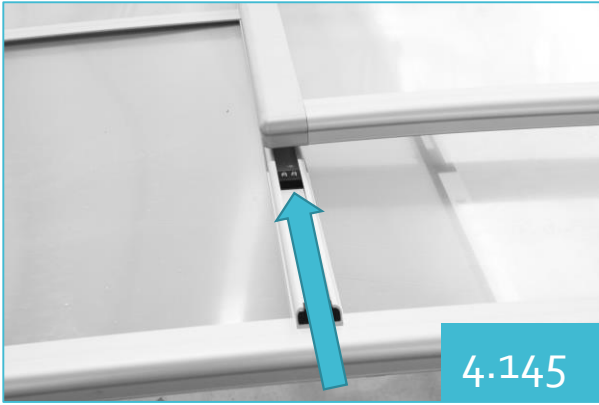







5.1

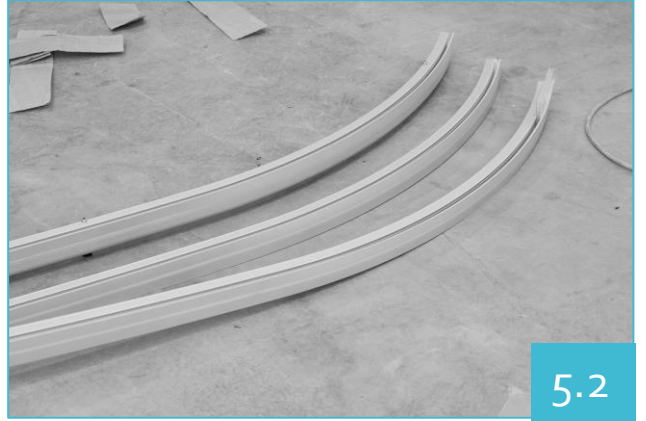

5.2

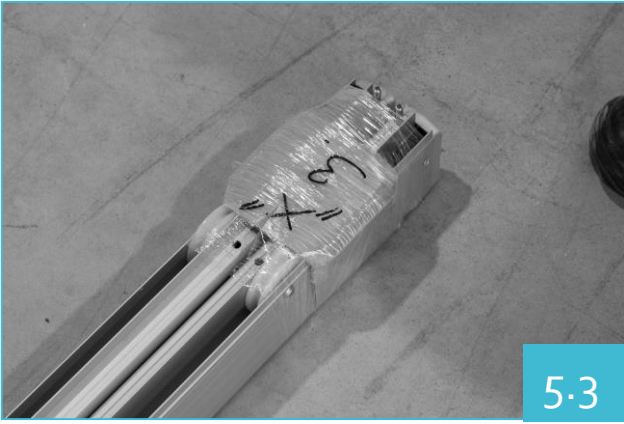

5.3



5.4



5.5



5.6

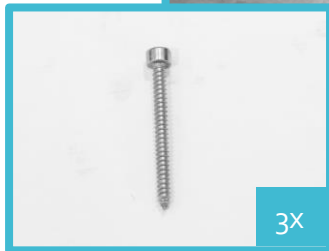

3x

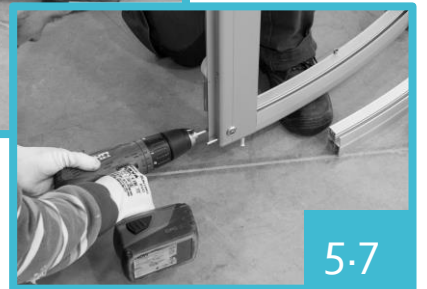

5.7



5.8



5.9



5.10



5.11



3x



5.12

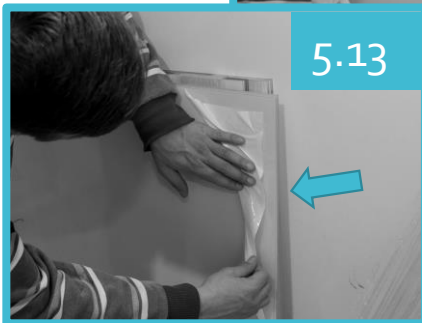

5.13

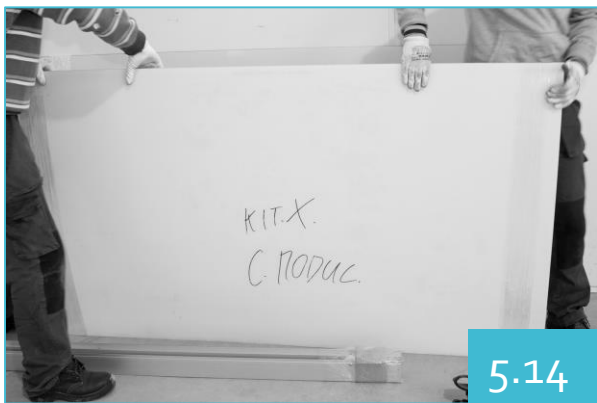

5.14



5.15



5.16



5.17

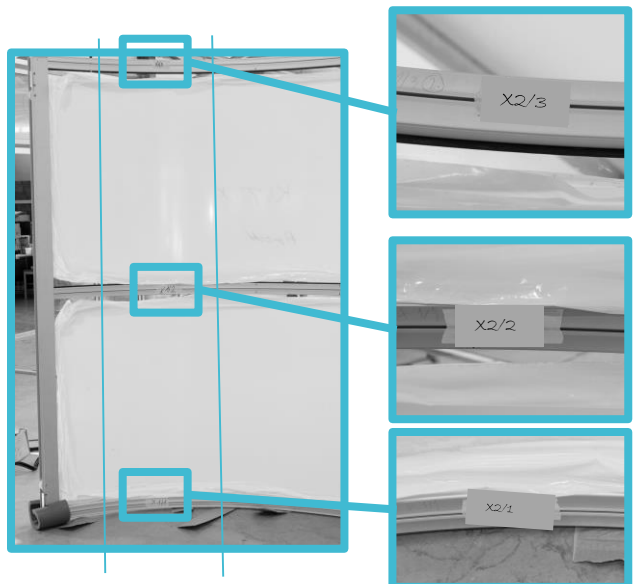



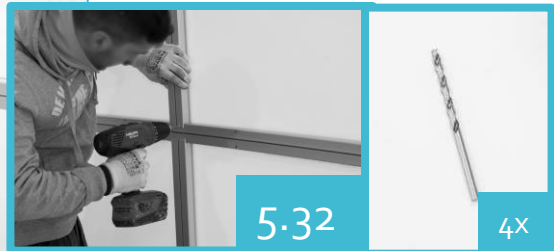





5.34

5.35

4x



5.36

5.37

2x



5.38

5.39

2x



8x



5.40



5.43



5.41



5.42

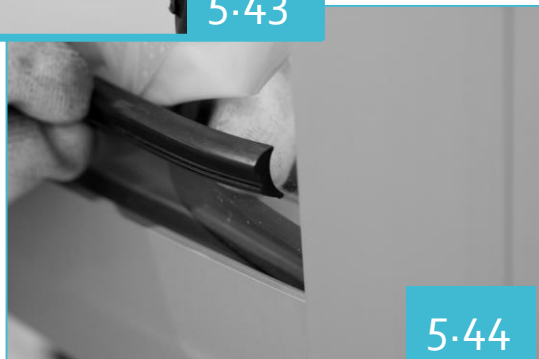

5.44



5.45



5.46



5.47



5.48



5.49

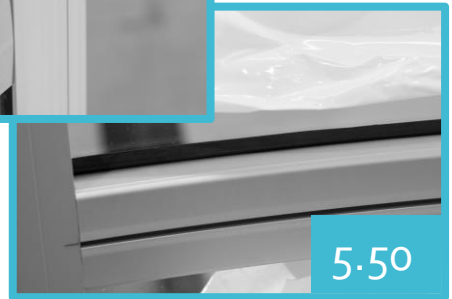

5.50



5.51



5.52



5.53



5.54



5.55



5.57



5.56

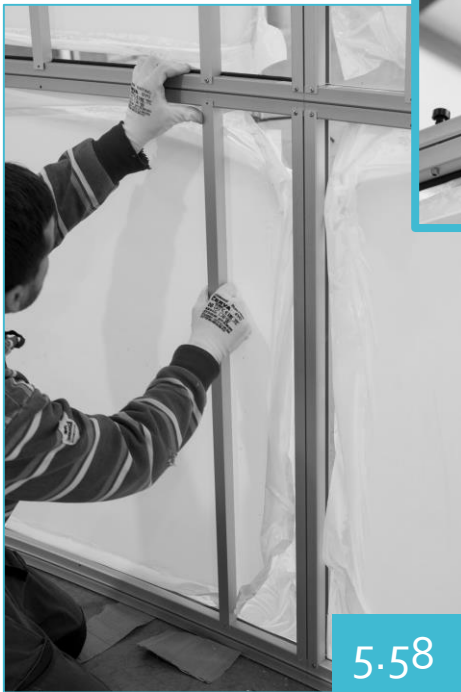

5.58



12X



5.59

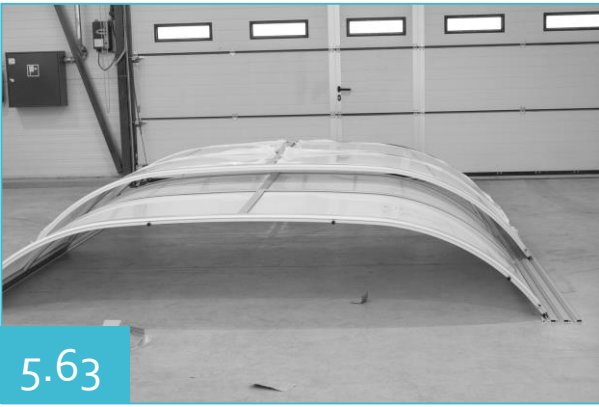
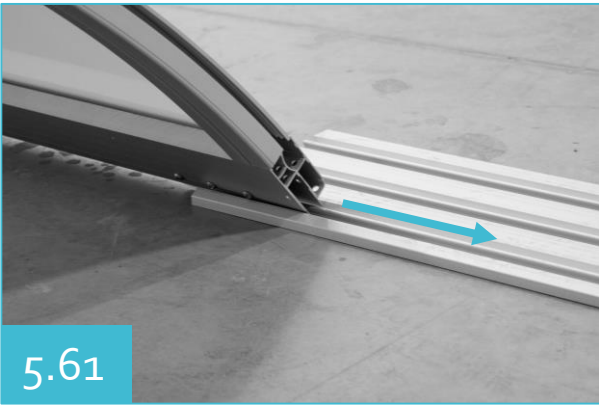





5.67



5.68



5.69



5.70



5.71



5.72



5.73



5.74



5.75

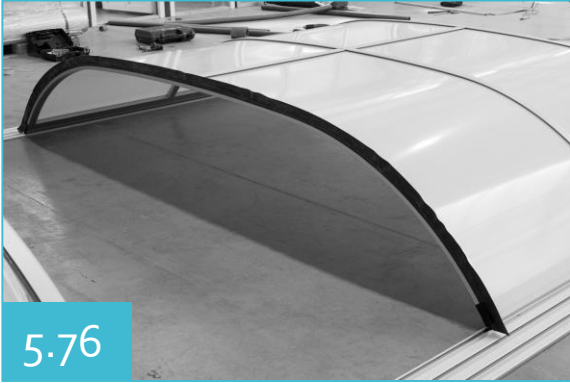

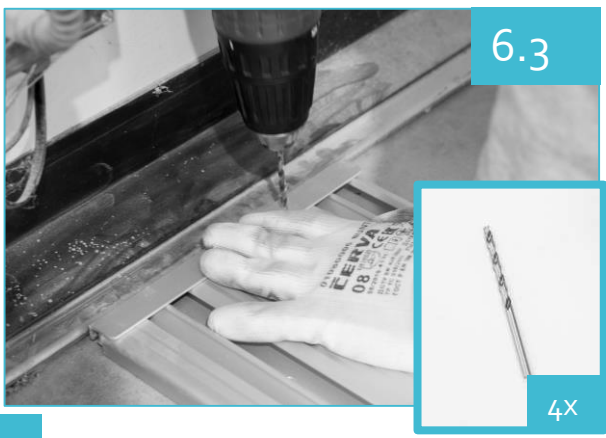
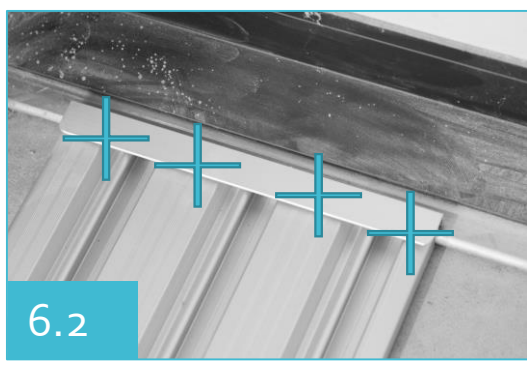
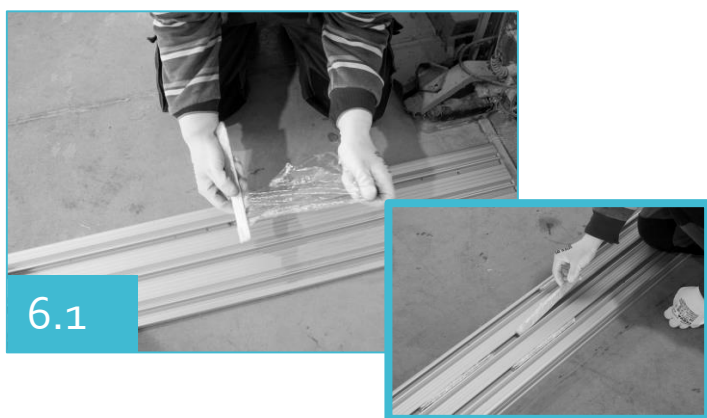

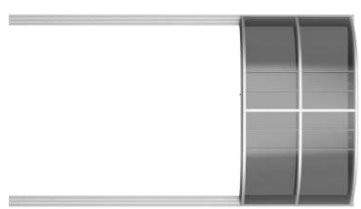
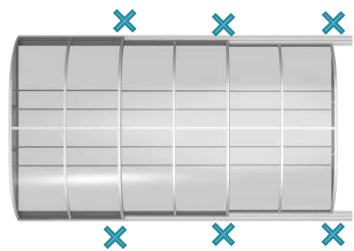
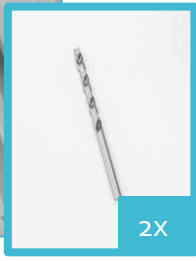
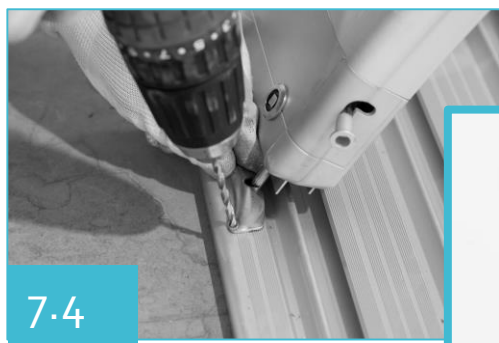
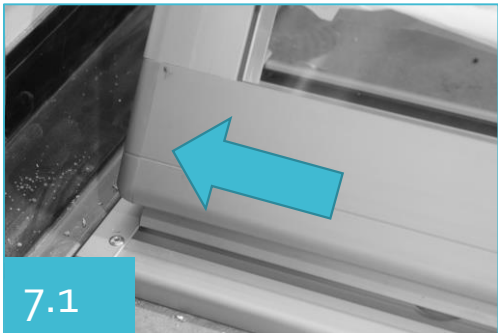

12X

